

Preform 48-41 - 75 g

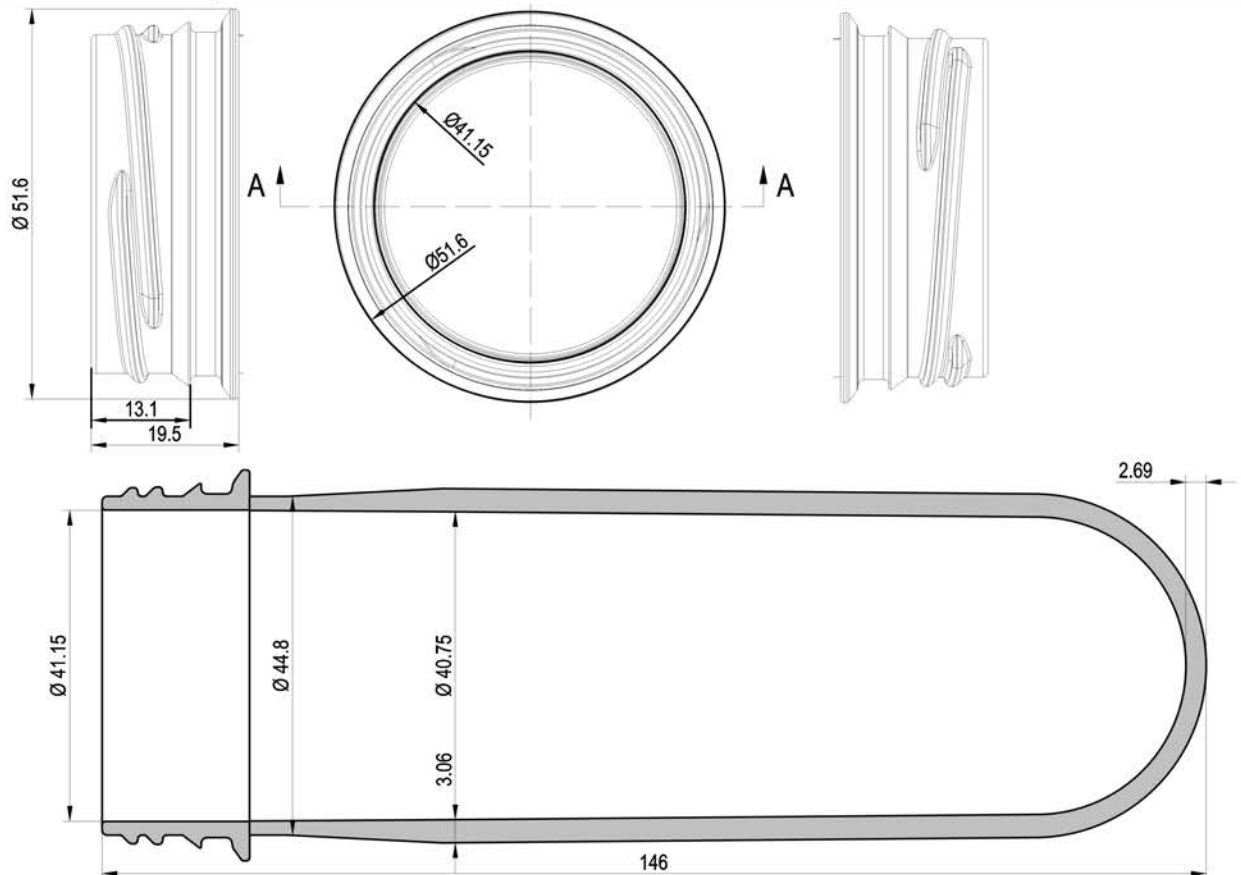

TECNICAL SPECIFICATION

DESCRIPTION	PREFORM 48-41 - 75 g
NECK TYPE	48-41
WEIGHT	75 g
NECK WEIGHT	9.05 g



MATERIAL	PET / R - PET
SPECIFIC WIEGHT	1.335 g/cm ²
PACKAGING	Pallet 100x120 cm - 120x120 cm Octabin 120x120x118 cm - 100x120x118 cm Polyethylene bag 200x250 cm - 190+20+20x250 cm
STORAGE	Store the product in a dry place not exposed to sunlight Maximum number of stackable Octabins 3 Before use, store for 24 hours in a room at a temperature between 18 ° -40 ° C Use the product within 12 months from the date of receipt

NOTE